

# DA11AEN

## Quick Reference Guide



### Introduction

Our DA11AEN has been designed to encode unbalanced or balanced 2ch analogue audio to Dante® digital signals. The DA11AEN allows any non-Dante® audio source such as mixing consoles, amplifiers, computers and Blustream Matrix products or distribution products to be connected as a source within a Dante® network. The DA11AEN is a plug & play device that is powered using either PoE (Power Over Ethernet) from any PoE network switch or via a local 12V power supply input. The DA11AEN also supports AES67 RTP audio transport.

#### FEATURES:

- Encodes unbalanced or balanced 2ch analogue audio to Dante® digital signals
- Supports 44.1, 48 & 96 KHz sample rates @ 24 Bit
- Configurable Dante® device latency (supports 1, 2 or 5ms configurable using Dante® Controller)
- Supports AES67 RTP audio transport
- Features Class 3 802.3af PoE for powering of product from any PoE switch
- Local 12V power supply input for when network switch does not support PoE\*  
 \* PS121PH power supply sold separately

### Front Panel

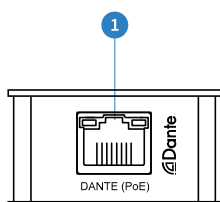

#### Connections:

- 1 Dante® Audio Output - RJ45 socket connects Dante® network.
- 2 DC Input - Connect to +12VDC power supply (not supplied) if device is not powered via a PoE switch
- 3 Audio Input - Phoenix Connector accepts balanced or unbalanced 2 channel audio input.

### Rear Panel

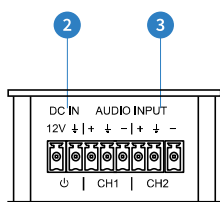

### Wiring Configuration

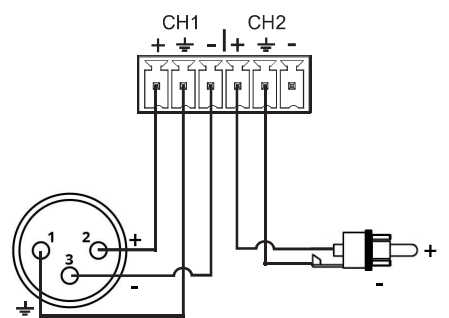

Balanced - XLR

Unbalanced - RCA

# Dante Controller

Dante Controller software is required in order to setup and configure the DA11AEN as well as control your Dante® network. Audinate provide extensive training videos and documentation on their website. This can be found here: <http://www.audinate.com/products/software/dante-controller>

Upon connecting your DA11AEN to a compatible network, the Dante Controller software should automatically discover the device. The DA11AEN will appear in the Dante Controller with a name denoted with “BLS”. On the “Routing” screen you can create audio routing between Dante® encoders and decoders in your system.

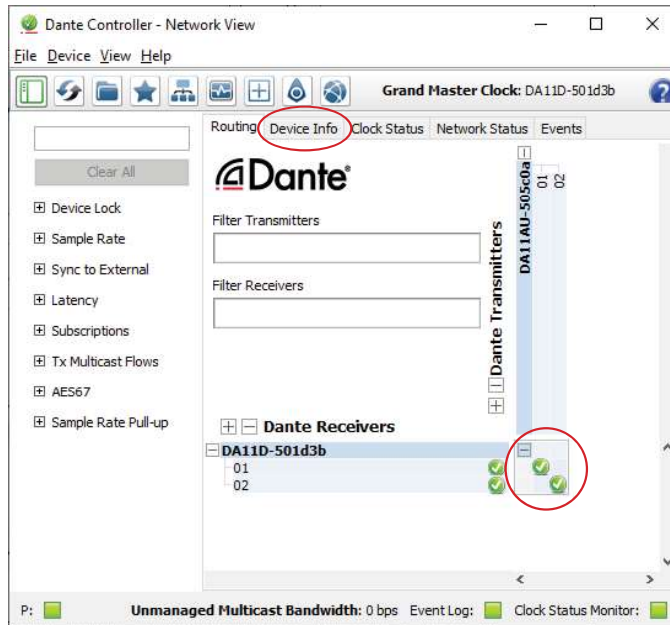

By default the DA11AEN is shipped with its network settings set to obtain an IP Address automatically. This means that if a DHCP server is present on your network, it will provide the DA11AEN with an IP Address. If no DHCP server is present then the DA11AEN will receive a default IP Address in the 169.254.xxx.xxx range. To change the IP Address of the DA11AEN, you must enter the “Network Config” menu in the “Device Info” screen of the Dante Controller software.

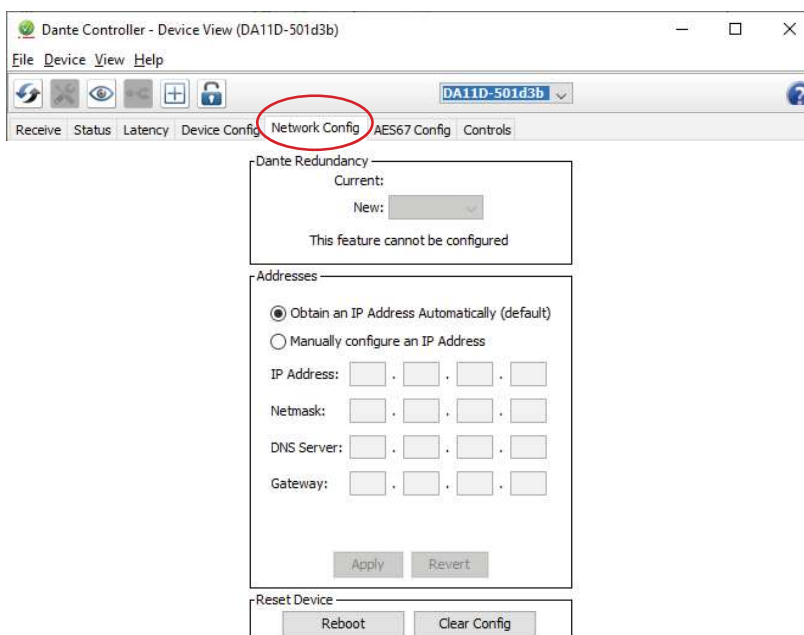

## Advanced Dante® Settings

It is also possible to change the settings of the DA11AEN under the “Device Info” screen in the Dante Controller software. To do so, select the “Device Config” menu.

Here we can adjust the sample rate of the DA11AEN. **Please Note:** that Dante® products can only transmit or receive audio from other Dante® products that are set up with the same sample rate. A mismatch in sample rate may stop audio from transmitting.

Under the “Device Config” screen we can also adjust the latency of the DA11AEN from 1, 2 or 5 milliseconds.

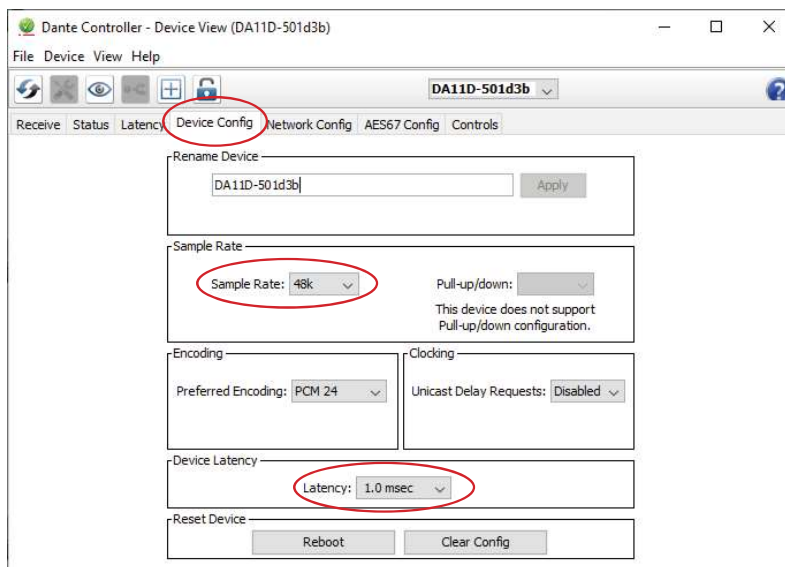

## Input Sensitivity Adjustment

Depending on the connected audio device, it may be necessary to adjust the input sensitivity.

The DA11AEN features a 5 pin switch on the side of the device to adjust the input sensitivity of each channel from various settings between +24dBu to -10dBV.

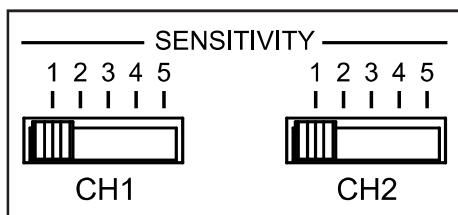

SWITCH POSITION	INPUT SENSITIVITY
1	+24dBu
2	+4dBu
3	+0dBu
4	0dBV
5	-10dBV

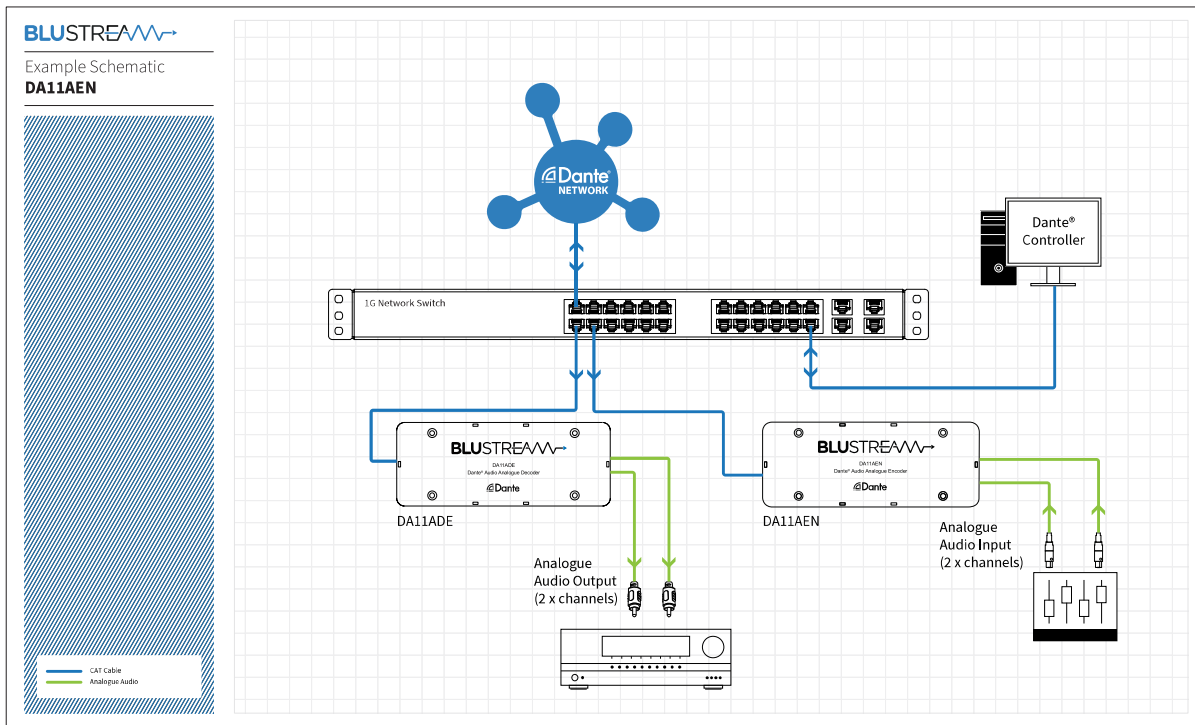

## Specifications

- Audio Input Connectors:** 6-pin Phoenix connector (2ch balanced / un-balanced analogue audio)
- Audio Output Connectors:** 1 x RJ45, female (100 Mbps Dante® network)
- Casing Dimensions (L x W x H):** 120mm x 47mm x 26mm
- Shipping Weight:** 0.3 Kg
- Operating Temperature:** 32°F to 104°F (0°C to 40°C)
- Storage Temperature:** - 4°F to 140°F (- 20°C to 60°C)
- Power Supply:** Class 3 IEEE 802.3af PoE PD or 12V/1A DC 2-PIN Phoenix connector

## Package Contents

- 1 x DA11AEN
- 1 x Quick Reference Guide

## Acknowledgements

Dante® is a registered trademark of Audinate Pty Ltd.

## Certifications

### FCC NOTICE

This equipment has been tested and found to comply with the limits for a Class B digital device, pursuant to part 15 of the FCC Rules. These limits are designed to provide reasonable protection against harmful interference in a residential installation. This equipment generates, uses, and can radiate radio frequency energy and, if not installed and used in accordance with the instructions, may cause harmful interference to radio communications. However, there is no guarantee that interference will not occur in a particular installation. If this equipment does cause harmful interference to radio or television reception, which can be determined by turning the equipment off and on, the user is encouraged to try to correct the interference by one or more of the following measures:

- Reorient or relocate the receiving antenna.
- Increase the separation between the equipment and receiver.
- Connect the equipment into an outlet on a circuit different from that to which the receiver is connected.
- Consult the dealer or an experienced radio/TV technician for help.

**CAUTION** - changes or modifications not expressly approved by the party responsible for compliance could void the user’s authority to operate the equipment.

### CANADA, INDUSTRY CANADA (IC) NOTICES

This Class B digital apparatus complies with Canadian ICES-003. Operation is subject to the following two conditions: (1) this device may not cause interference, and (2) this device must accept any interference, including interference that may cause undesired operation of the device.

### CORRECT DISPOSAL OF THIS PRODUCT

This marking indicates that this product should not be disposed with other household wastes. To prevent possible harm to the environment or human health from uncontrolled waste disposal, recycle it responsibly to promote the sustainable reuse of material resources. To return your used device, please use the return and collection systems or contact the retailer where the product was purchased. They can take this product for environmentally safe recycling.